

NTS-4000-S Installation and Configuration Manual



CONTENTS

Contents.....	2
Introduction	4
Features	4
What should be shipped	5
Standard Parts.....	5
Optional Parts	5
Technical Specification.....	6
System Overview	7
NTS-4000-S.....	7
GPS Antenna	8
MSF Antenna.....	9
DCF Antenna	10
WWVB Antenna	11
Wiring the unit	12
GPS.....	12
Extending the antenna with Cat5e/Cat6 Cable.....	12
Extending the antenna with eight - Core Cable	13
Radio – MSF/DCF/WWVB	14
Extending the antenna with Cat5e/Cat6 Cable.....	14
Extending the antenna with four - Core Cable	15
Setting up the Unit.....	16
Connecting everything up.....	16
Server Location	16
Connect to Network.....	16
Install Antenna	16
Connecting the Server to the Antenna	16
Configuration	17
Software Installation and Configuration.....	18
Install Windows based Configuration Software.....	18
Configure Network Settings.....	23
Time Server Configuration Options	24
Upgrade Firmware	24
Troubleshooting.....	25



NTS-4000-S

Debug the Unit.....	26
Installing the NESDK Software	26
Using the NESDK Software.....	31
Support Website	33
Warranty and Maintenance.....	35
Warranty	35
Technical Support, Repair and Returns.....	35



INTRODUCTION

The NTS-4000-S timeserver provides the correct time to computers on a local network (LAN).

Correct time is derived from either Global Positioning Satellites (GPS), or Radio-based broadcasts from Cumbria in the UK (MSF), Frankfurt in Europe (DCF), and Fort Collins, Colorado in the US (WWVB). Once installed on a computer network the NTS-4000-S provides a standalone location for the Network Time Protocol (NTP).

Each PC on the network can retrieve the time from the server using an NTP Client. The NTS-4000-S Time Server provides a bridge between Ethernet wired LAN's and GPS and Radio-based time sources.

FEATURES

- Consistent and reliable timing.
- Quick and user friendly setup.
- At 8 Watts, Unit stays cool maintaining efficiency.
- Compact standalone unit.
- Quick and easy readings from backlit LCD display.
- Interfaces directly to 10/100Mbps IEEE 802.3 Ethernet networks.
- Firmware is stored in flash memory and can be upgraded.
- Power and network activity LED indicators.



WHAT SHOULD BE SHIPPED

STANDARD PARTS

- NTS-4000-S standalone unit
- IEC power cable
- GPS or MSF or DCF or WWVB antenna *
- Junction Box and IDC Cable Tool
- Mounting bracket and fixing for antenna
- CD containing manual and software

OPTIONAL PARTS

- Light Arrestor(s)
- Cable for extending the antenna(s)
- Gold and Premium Support
- Digital Wall Clock - Ethernet Powered
- Secondary Time Source Available - GPS Units only
- Antenna Cable - Available from 100 to 1,000 metre rolls
- Additional Power Supply - Recommended from 550 metres onwards

* The antennas provided will depend on which has been ordered, however, all units come with at least one antenna

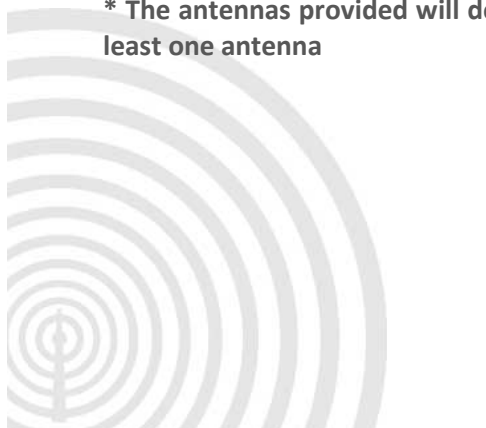

TECHNICAL SPECIFICATION

Protocols - NTP & SNTP	NTP v2 (RFC 1119) NTP v3 (RFC 1305) NTP v4 (RFC 2131) SNTP v3 (RFC 1769) SNTP v4 (RFC 2030)
Configuration	NTP Software
Technical Standard	NEMA 0183 V.2 Compliant
Network Interface	Standard 10/100 Base-T, RJ-45 Network Connection
MTBF Estimated	45,000 hrs.
Display	LCD with Backlight
Operating System	Proprietary OS (PIC Chip)
Operating Temperatures	0-50°C (32-122°F)
Heat Dissipation	80 BTU Per hour
Humidity	Max. 85% Non-Condensing
Mount	Rack
Function	Stratum 1 Time Server
Network Accuracy	Network: +/- 5 Milliseconds, Typical GPS/Radio: <1 Microseconds, Relative to UTC
NTP Time Requests	Up To 57 Per Sec
Power Supply Universal	85-260V, 47-63Hz
Power Consumption	8 Watts
Dimensions (mm) Packed	Packed Up: (H) 160 (W) 620 (D) 510
Unpacked	Unpacked 1U: (H) 45 (W) 425 (D) 163
Properties	Powder Coated Steel
Weight Packed	4.2kg
Unpacked with Antenna	2.4kg
Source	Satellite Radio
External	Active 12 Channel GPS MSF/DCF/WWVB Antenna



SYSTEM OVERVIEW

NTS-4000-S

The Galleon 4000 network time server synchronises time and provides a reliable stratum 1 response with 3,000 time requests per minute.

The IP address can either be automatically configured by DHCP or a static IP address can be entered manually.

Displaying necessary run-time information for the NTP subsystem on a backlit screen, the unit also supports NTP software and acts as a secure shell.



GPS ANTENNA

Tracking up to 12 satellites at the same time, GPS offers an accurate signal capable of a reliable and consistent reading anywhere in the world. Used extensively for synchronising time from one location to another, GPS signals are received globally and maintain a high level of accuracy.

Functional up to 1000m (3,000 ft.) away from the time server, additional cable length can be added to the supplied 10m to increase cable size to desired length. An extra power supply is recommended past the length of 550m to ensure the unit is running at optimum efficiency.

The GPS antenna is encased in a weatherproof IP65 enclosure and should be mounted on the roof of a building with a 180-degree view of the sky.

The antenna can be mounted to the side of the building; however, limiting the view of the sky will have an effect on the units' ability to synchronise. Units mounted to the side of the building will experience short periods of time where the antenna is unable to see the three satellites required to achieve synchronisation.

Some things to avoid are older computer monitors, switch mode power supplies and air conditioning units.

The GPS antenna uses eight-core signal cable and will function on a cable run of up to 550 metres drawing power from the rack-mount unit, if you require the antenna to have an extended cable run of up to 1,000 metres then a power supply is required. This power supply feeds directly into the GPS antenna and as such, would need to be located on the roof too. In most cases however, 550 metres is more than adequate.

The Operating temperature for the antenna is -40 Celsius to +85 Celsius so it may be worth noting that the temperature inside the enclosure can be considerably different from the external temperature, especially when the antenna is located in a position where it is in direct sunlight.

When mounting a GPS antenna it may be worth noting that satellites dishes can have a negative effect on the unit, it's best to keep the GPS antenna at least ten metres from them.



MSF ANTENNA

The MSF signal is broadcast from Anthorn in Cumbria and is maintained at a reliable frequency of 60 kHz, delivering a steady signal undisrupted by changing weather conditions and operational 24 hours a day. The radio signal is designed to cover the whole of the United Kingdom.

Functional up to 1000m (3,000 ft.) away from the time server, additional cable length can be added to the supplied 10m, to increase cable size to the desired length. An extra power supply is recommended past the length of 550m to ensure the unit is running at optimum efficiency.

One thing to bear in mind with a radio-based antenna is that certain electrical equipment generates noise on the same frequency as the radio signal and can cause interference. Some things to avoid are older computer monitors, switch mode power supplies and air conditioning units.

Radio based antennas are also directional antennas. The front of the antenna (this is the opposite side to where the cable enters the weatherproof box) should be facing the transmitter for the best signal reception.

For more information on the MSF signal, including information on scheduled maintenance times please refer to the National Physics Laboratory's website at www.npl.co.uk



DCF ANTENNA

The DCF antenna receives a radio signal broadcast at 77.5 kHz from Frankfurt (Main). The signal covers the whole of Germany and impressively most of Europe too.

Functional up to 1000m (3,000 ft.) away from the time server, additional cable length can be added to the supplied 10m, to increase cable size to the desired length. An extra power supply is recommended past the length of 550m to ensure the unit is running at optimum efficiency.

One thing to bear in mind with a radio-based antenna is that certain electrical equipment generates noise on the same frequency as the radio signal and can cause interference. Some things to avoid are older computer monitors, switch mode power supplies and air conditioning units.

Radio based antennas are also directional antennas. The front of the antenna (this is the opposite side to where the cable enters the box) should be facing the transmitter for the best signal reception.

For more information on the DCF signal including information on scheduled maintenance times, please refer to the Physikalisch-Technische Bundesanstalt website at www.ptb.de English can be selected via the menu located at the top left side of the site.

There is an alternative website for information on the DCF signal, however, please note this website is provided only in German at www.dcf77.de



WWVB ANTENNA

The WWVB antenna receives a radio signal broadcast at 60 kHz from two transmitters near Fort Collins in Colorado. One benefit of using the WWVB signal is that as they have two transmitters that have different scheduled down times, the WWVB signal is not affected by maintenance.

Functional up to 1000m (3,000 ft.) away from the time server, additional cable length can be added to the supplied 10m, to increase cable size to the desired length. An extra power supply is recommended past the length of 550m to ensure the unit is running at optimum efficiency.

One thing to bear in mind with a radio-based antenna is that certain electrical equipment generates noise on the same frequency as the radio signal and can cause interference. Some things to avoid are older computer monitors, switch mode power supplies and air conditioning units.

Radio based antennas are also directional antennas. The front of the antenna (this is the opposite side to where the cable enters the box) should be facing the transmitter for the best signal reception.

For more information on the WWVB signal please refer to the National Institute of Standards and Technology (NIST) under the Time and Frequency Division at www.nist.gov/pml/div688/grp40/wwvb.cfm



WIRING THE UNIT

GPS

Extending the antenna with Cat5e/Cat6 Cable

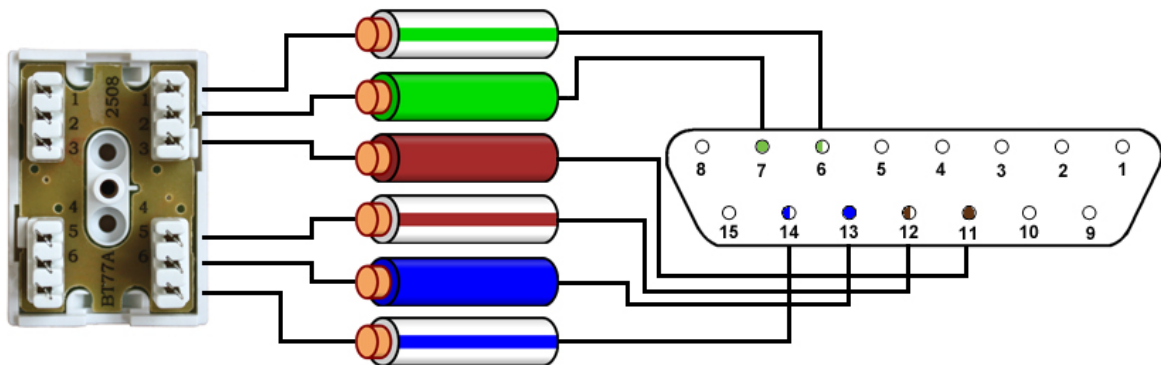

15 Way D-Type Pin	Cable Colour
6	Green/White
7	Green
11	Brown
12	Brown/White
13	Blue
14	Blue/White



Extending the antenna with eight - Core Cable

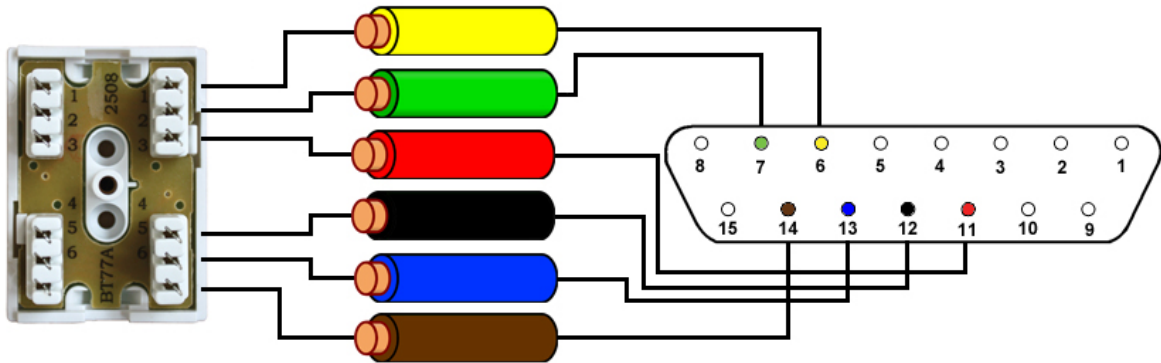

15 Way D-Type Pin	Cable Colour
6	Yellow
7	Green
11	Red
12	Black
13	Blue
14	Brown



RADIO – MSF/DCF/WWVB

Extending the antenna with Cat5e/Cat6 Cable

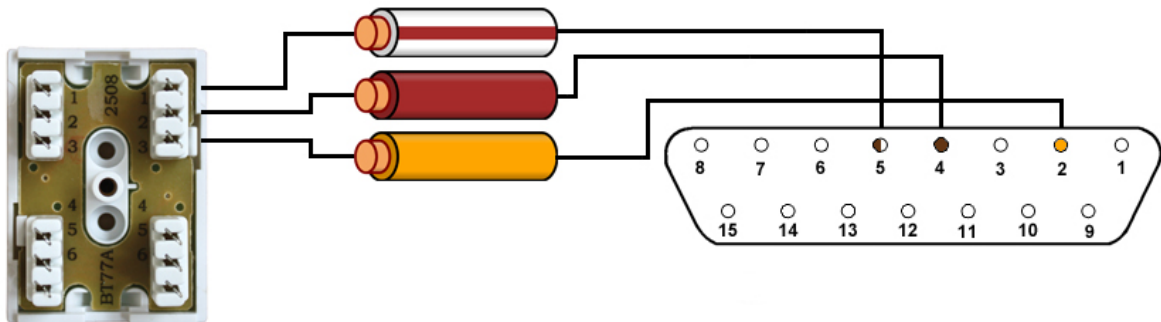
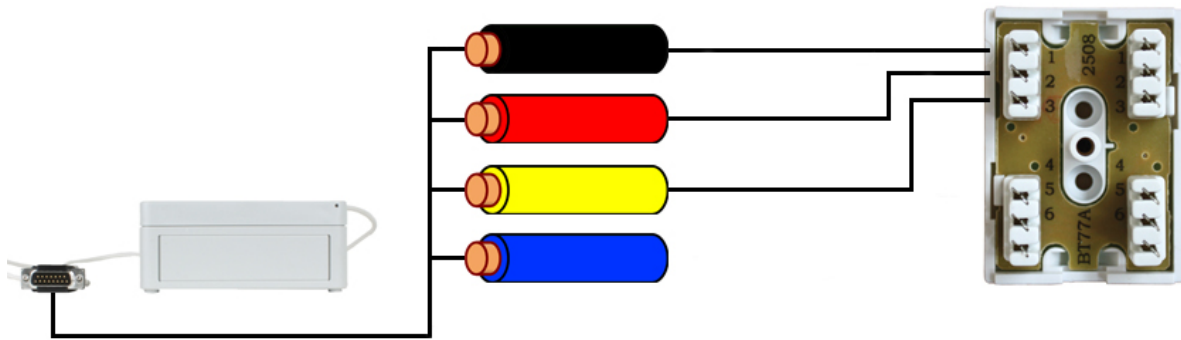

15 Way D-Type Pin	Cable Colour
2	Orange
4	Brown
5	Brown/White

Extending the antenna with four - Core Cable

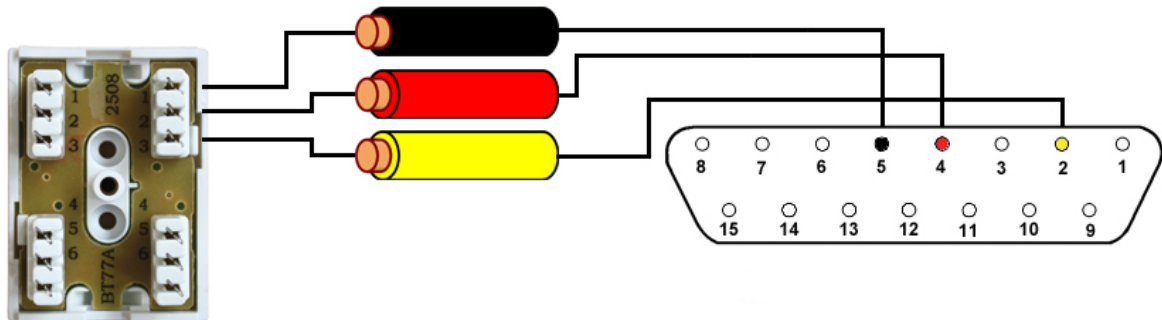
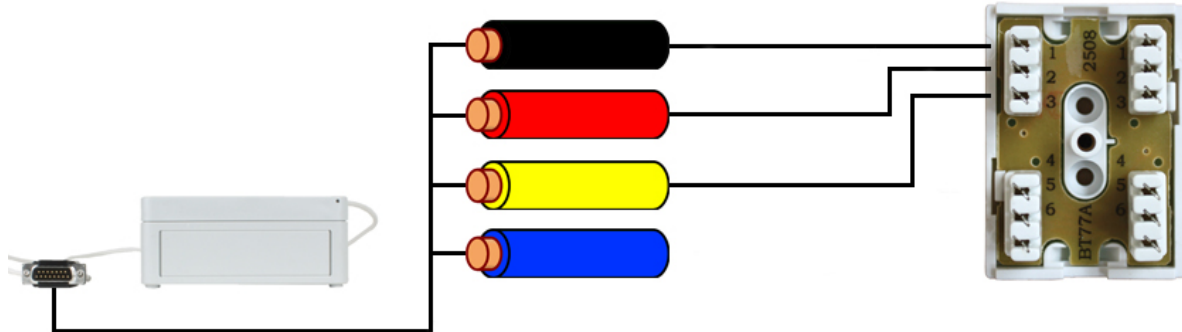

15 Way D-Type Pin	Cable Colour
2	Yellow
4	Red
5	Black



SETTING UP THE UNIT

CONNECTING EVERYTHING UP

Server Location

Choose a suitable location for the NTS-4000-S; please bear in mind you will need to run a cable from this location preferably to the roof of the building or to a window.

Connect to Network

Connect the NTS-4000-S to the network using a standard RJ-45 cable. If your network supports DHCP then the unit will automatically obtain an IP Address.

Install Antenna

Choose an area to mount the GPS/Radio Antenna; the ideal place would be the roof of the building with a clear view of the sky (GPS) or facing the correct Transmitter (Radio). Things to avoid are air conditioning units and power distribution units, as these will cause electrical interference.

Please note that if you are extending the cable to a length of 550m or greater, then you will need an extra power source, located either on the roof or can be accessed from the roof.

Connecting the Server to the Antenna

The cable should be run from the rack mount enclosure to the selected mounting position.

Please note that it is a good idea to leave some slack cable in case you need to move the unit later. Also the maximum cable length should not exceed 1000m.

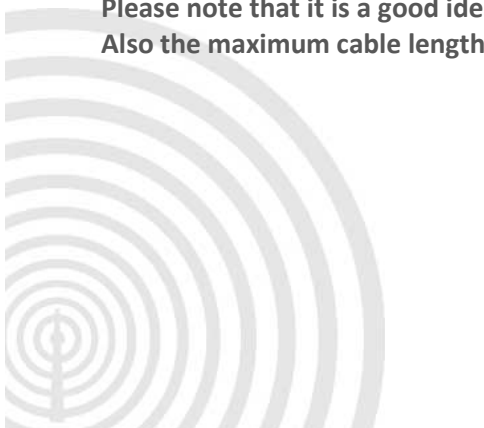

CONFIGURATION

Once everything is connected up, the NTS-4000-S can then be powered up. The unit will start up and begin running the necessary processes. The LCD display will start and show the following:

- LCD INITIALISED
- ASMINT DISPON 20M

Next the unit will check for data coming into the serial connector:

- WAITING SERIAL DATA

The unit will display the current software version:

- S/W Version 205

The unit will seek to synchronise with either GPS or Radio:

- Waiting for 1st sync
- Unsynchronised

During the waiting period for synchronisation, the Unit will remain in an 'unsynchronised state':

- GPS: No Fix
- Unsynchronised

The unit will show that it 'knows' there is an antenna attached and understands the data:

- GPS: Data OK
- Fri Jul 15 13:58:31

Once in a 'synchronised state' the unit will display:

- Using GPS *or* MSF
- Fri Jul 15 13:59:58

In this state, the display will show the GPS/Radio information as well as the date and time

At all times, the unit will display the IP Address in the message cycle, as well as the number of NTP Messages sent on the network.

SOFTWARE INSTALLATION AND CONFIGURATION

Install Windows based Configuration Software

You need to install and run the Windows based configuration software to set up the network connection, which will allow you to configure NTP Clients to use the NTS-4000-S.

Run the setup program called 'NTS-4000-Config-2.0.exe'.

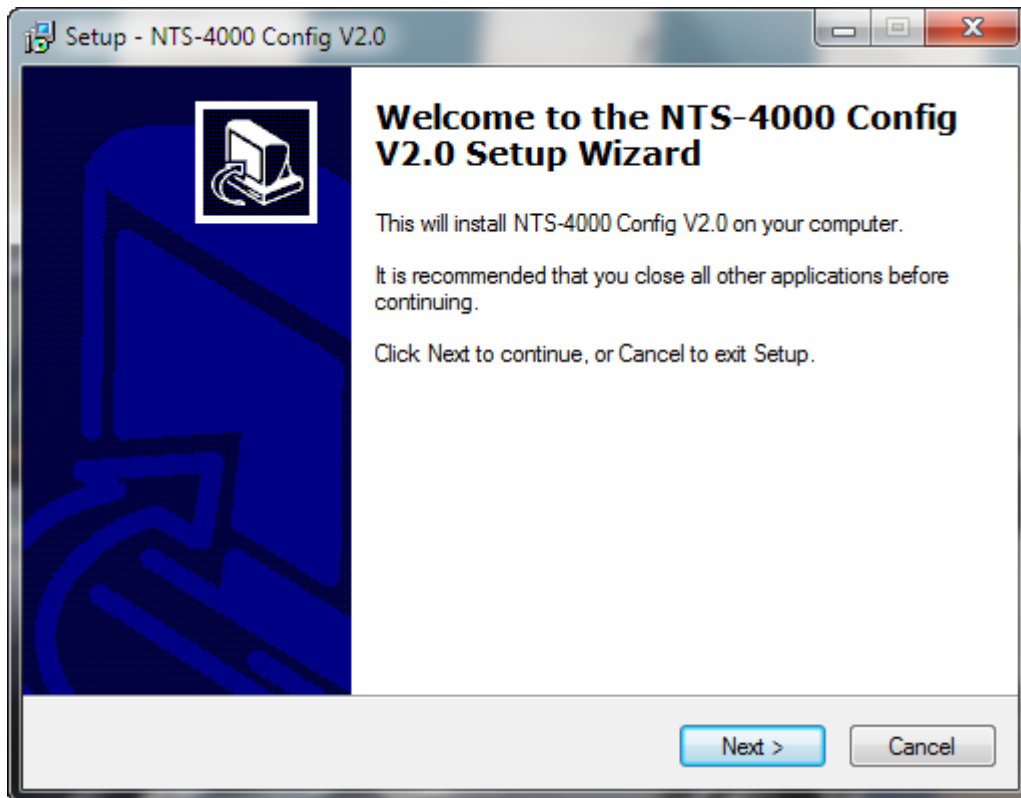

Click 'Next'.



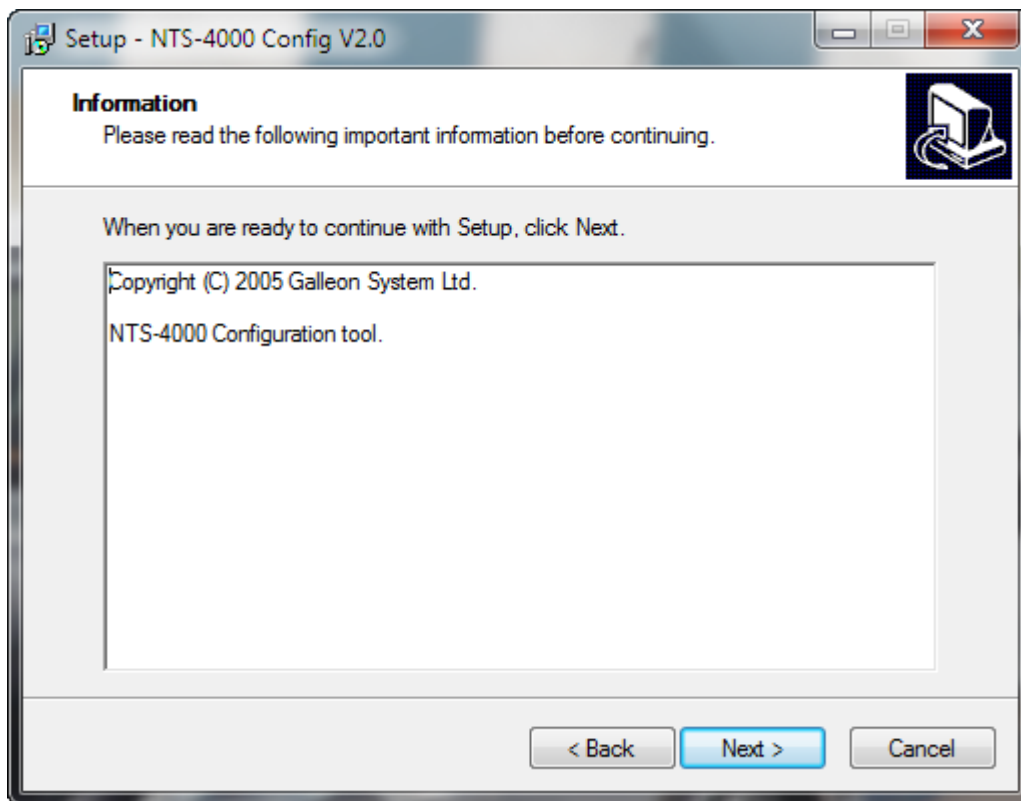

Click 'Next'.

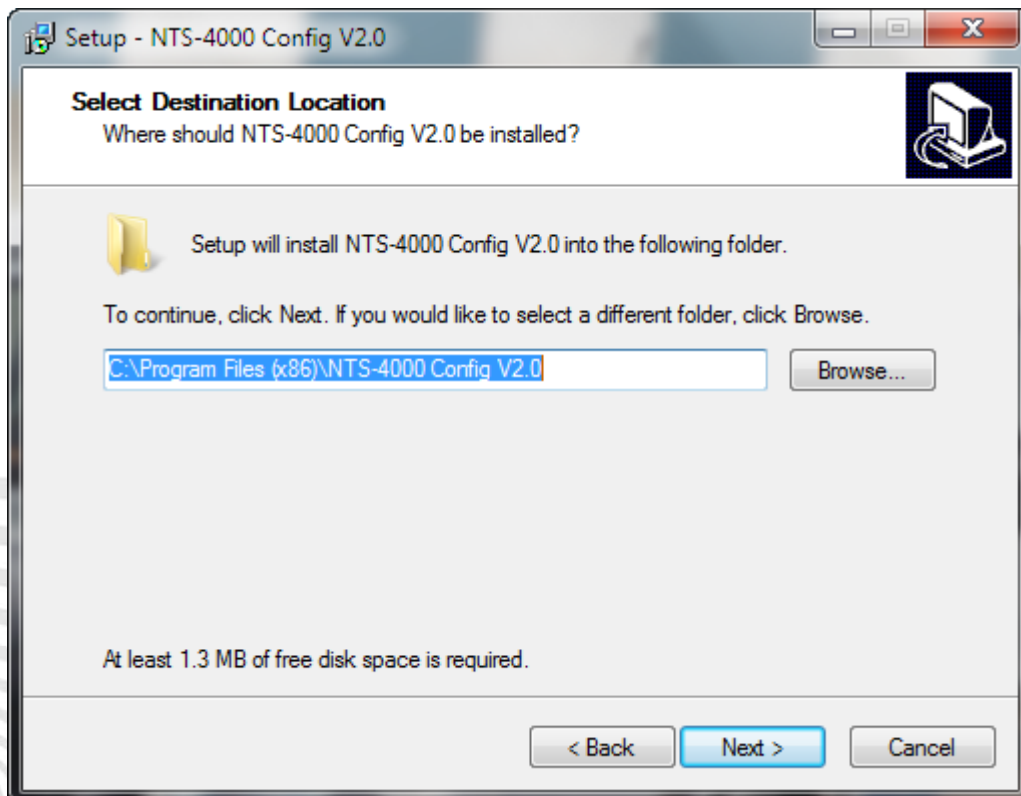

Select where you would like the program installed and click 'Next'.

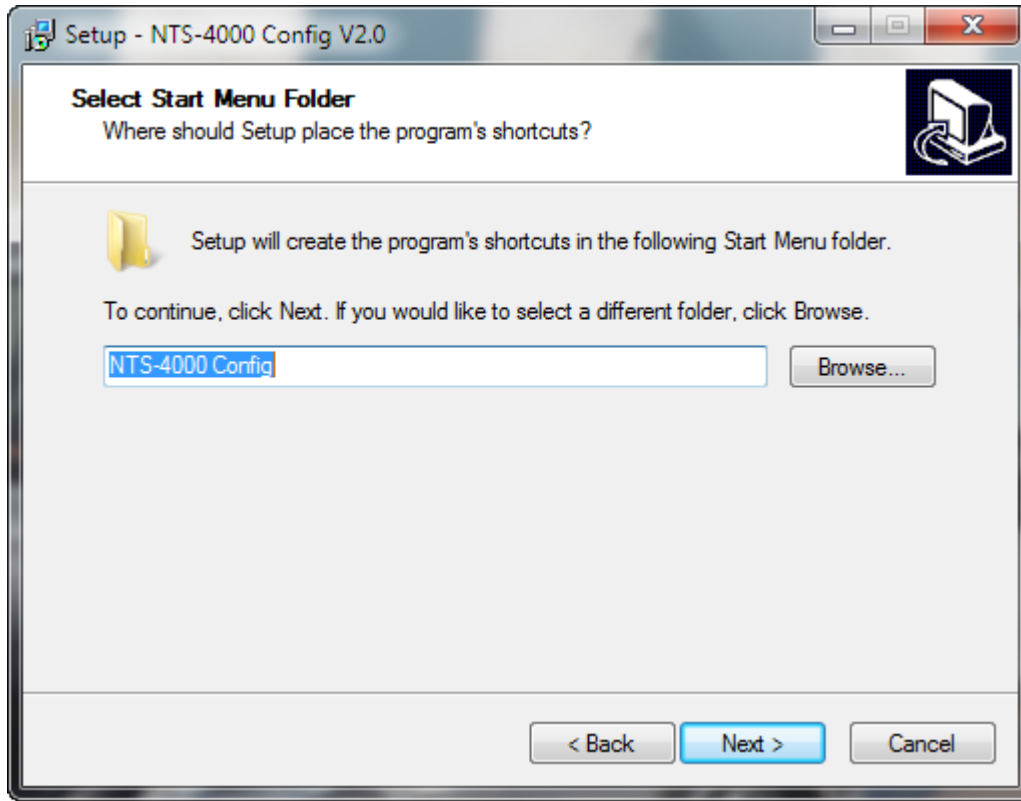

Select the Program Group and click 'Next'.

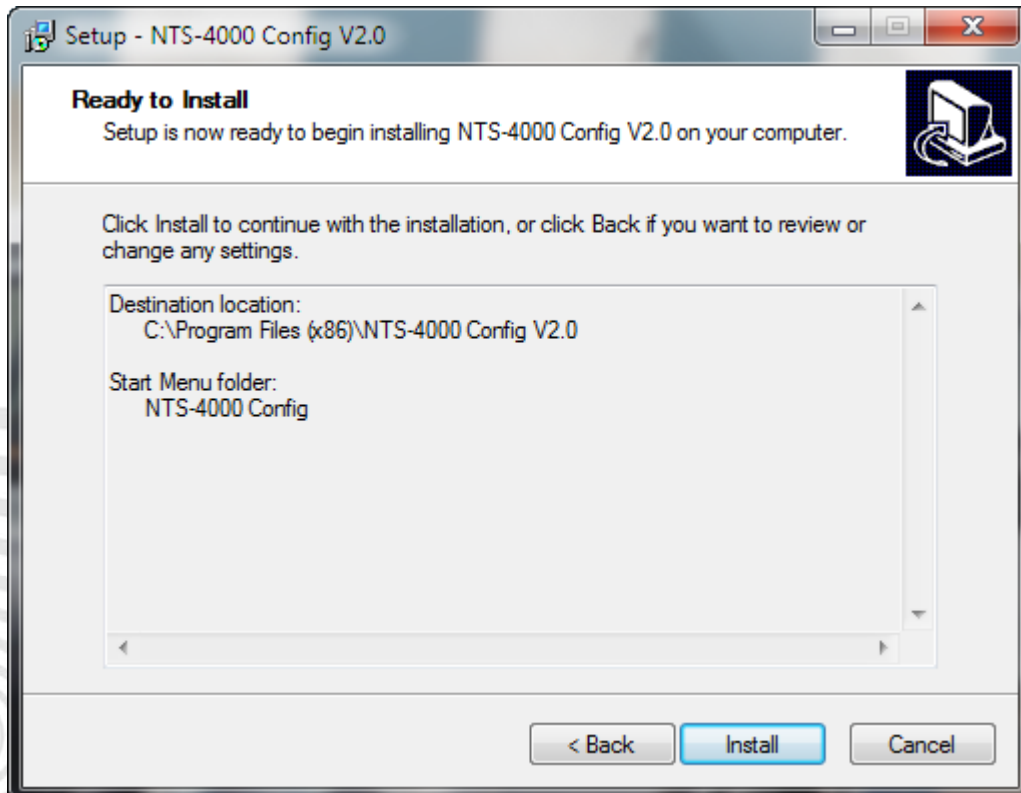

Review the options and click

'Install'.

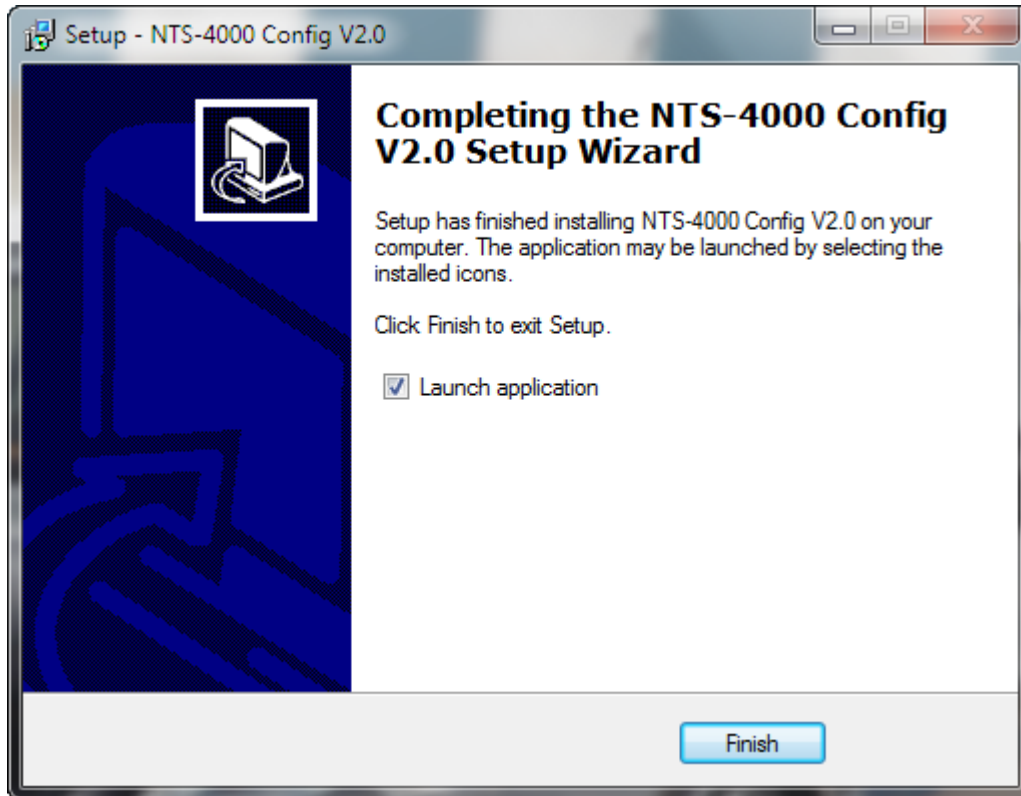

Click 'Finish' to exit the setup program. The Configuration program will be started straight away if the option here is left checked.

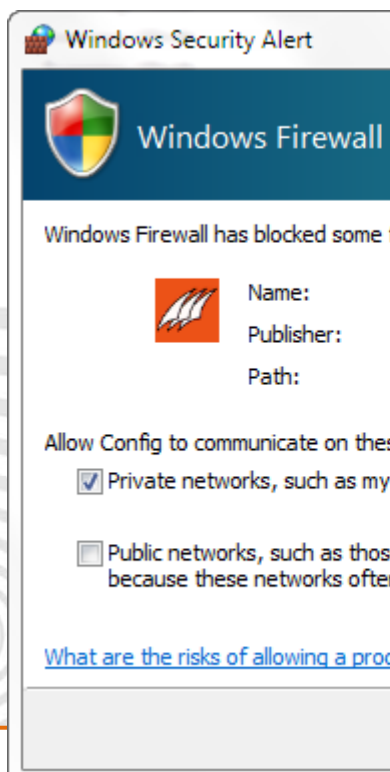

program access for it to work correctly.

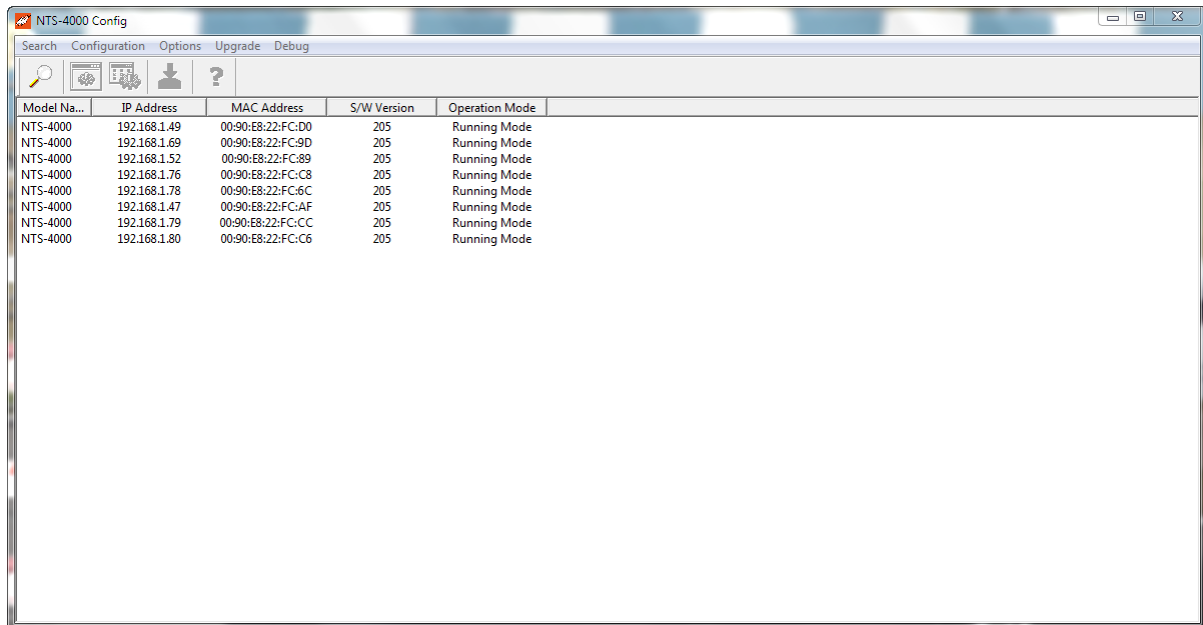

Model Na...	IP Address	MAC Address	S/W Version	Operation Mode
NTS-4000	192.168.1.49	00:90:E8:22:FC:D0	205	Running Mode
NTS-4000	192.168.1.69	00:90:E8:22:FC:9D	205	Running Mode
NTS-4000	192.168.1.52	00:90:E8:22:FC:89	205	Running Mode
NTS-4000	192.168.1.76	00:90:E8:22:FC:C8	205	Running Mode
NTS-4000	192.168.1.78	00:90:E8:22:FC:6C	205	Running Mode
NTS-4000	192.168.1.47	00:90:E8:22:FC:AF	205	Running Mode
NTS-4000	192.168.1.79	00:90:E8:22:FC:CC	205	Running Mode
NTS-4000	192.168.1.80	00:90:E8:22:FC:C6	205	Running Mode

All of the NTS-4000-S Devices found are shown along with their current IP Address (if any), Hardware MAC Address and Software Version Number.

Select the unit you would like to configure and click 'Configuration'.



Configure Network Settings

The first configuration step is to set up the network so other devices can use the NTS-4000-S. The display always shows the currently active IP Address for the network connection.

The NTS-4000-S must be configured with a valid IP Address before the NTP options can be set.

First, determine whether you are going to use DHCP (automatic network configuration) or a static IP Address.

DHCP is short for Dynamic Host Configuration Protocol for assigning dynamic IP Addresses to devices on a network. With dynamic addressing, a device can have a different IP Address every time it connects to the network.

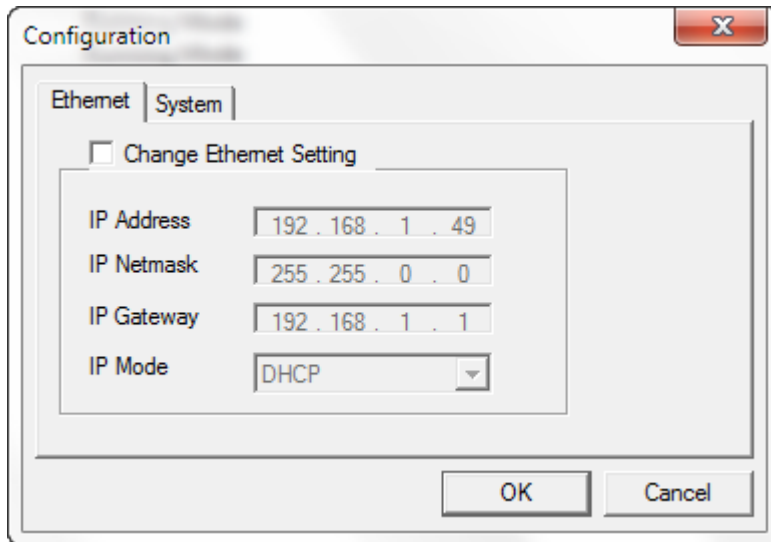

DHCP is on as default. You can change this to be static, by selecting 'Static IP' in the 'IP Mode'.

This is the easiest way to set up the server initially; however, it is recommended that a static address be assigned to the server, if possible, to fix the address permanently. With automatically assigned addresses using DHCP it is possible that the address could change, possibly requiring client Reconfiguration.

To assign static settings to the network, first determine the following:

- IP Address the server should use;
- Subnet Mask;
- Default Gateway.

These should be available from your network administrator.

Once the NTS-4000-S is correctly configured, the Windows Configuration program is no longer required for normal operation.

Time Server Configuration Options

To set the Time Server options for the NTS-4000-S, select the device as before, then click 'Options'. The current status is shown along with the options to send broadcasts and/or syslog messages.

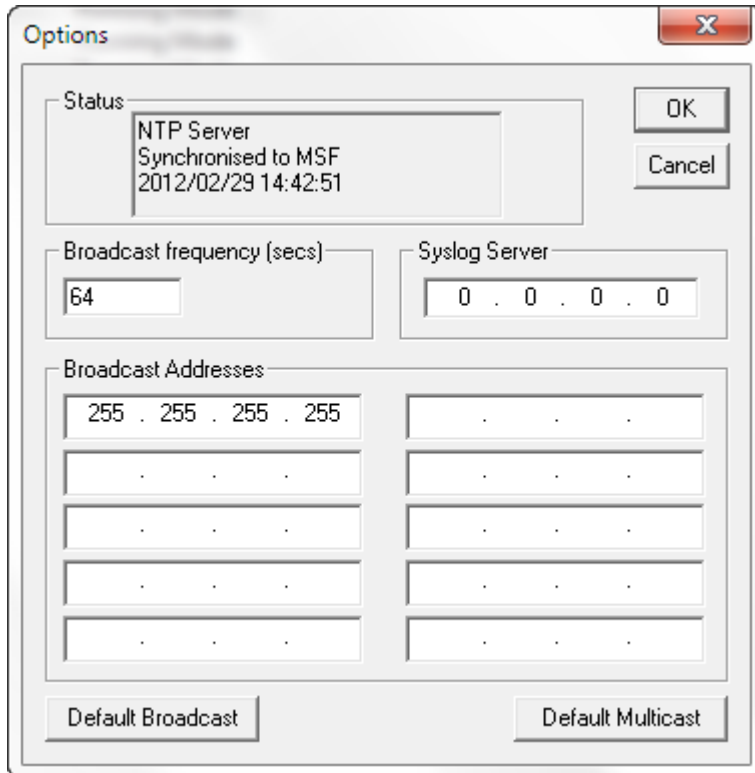

Broadcast Addresses	
255 . 255 . 255 . 255	.
.	.
.	.
.	.
.	.

Broadcasts are a way of sending a single timestamp to many computers at the same time. Multicasts are similar but may span more than one subnet if the network is set to do so. If the value of the broadcast frequency is set to 0, none are sent.

Other subnets may be sent broadcasts (called direct broadcasts). E.g. one could send a broadcast to subnet 192.168.10.xxx using a broadcast address of 192.168.10.255

The syslog server is where system status messages are sent using the syslog protocol. If this is set to 0.0.0.0 no syslog messages are ever sent.

Upgrade Firmware

The 'Upgrade' option allows the NTS-4000-S Software to be upgraded to add new features and/or fix problems. Select the device to be upgraded and click 'Upgrade'. Select the firmware file and click 'Open'. After approximately 1 minute, the NTS-4000-S will have completed the upgrade and restart automatically.

Check galleonsupport.com for any updates to the NTS-4000-S Software.

TROUBLESHOOTING

Use this section to quickly troubleshoot minor issues or common problems.

For any further support, please contact us using our Support Website, which can be found at:

galleonsupport.com

Q) What do the LED's on the front of the unit indicate?

A) On the front of the unit there are 3 lights and an on/off switch. The red 'A' light indicates that there is power to the unit. The green 'B' light will flash when the unit is picking up the signal from the GPS antenna. The yellow 'C' light will flash when the unit is picking up the signal from the Radio antenna. Both the green 'B' light and the yellow 'C' lights will flash when the unit is picking up the signal from both the antennas.

Q) On the LCD display the time on my rack-mount appears to be incorrect, however the unit is synchronised.

A) The rack-mount unit uses UTC (Coordinated Universal Time). This is time without time-zones or daylight savings.

Q) I forgot my password how can I reset?

A) Simply put, don't forget your password as the unit will have to be shipped back to us and we will have to reset the unit and send it back to you.



TECHNICAL SUPPORT

DEBUG THE UNIT

Installing the NESDK Software

You need to install and run the Windows based debug software to obtain any debugging information, which will allow you to assist Technical Support staff if they are contacted.

Run the setup program called 'NESDK_2.9.exe'.

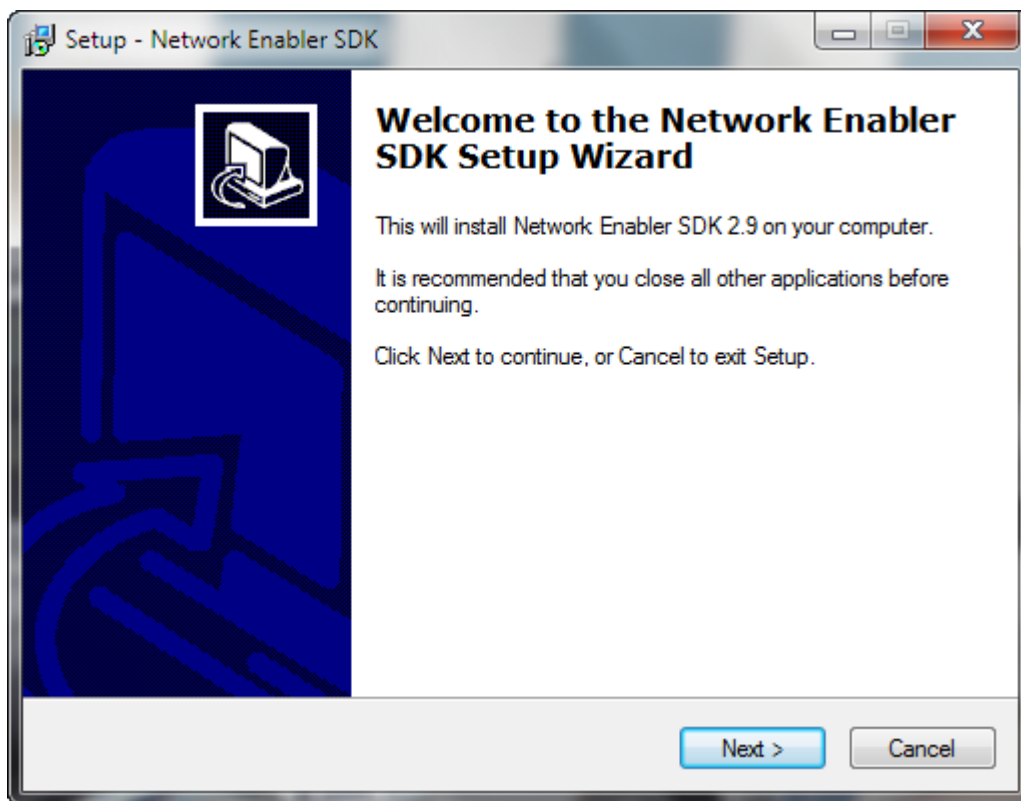

Click 'Next'.



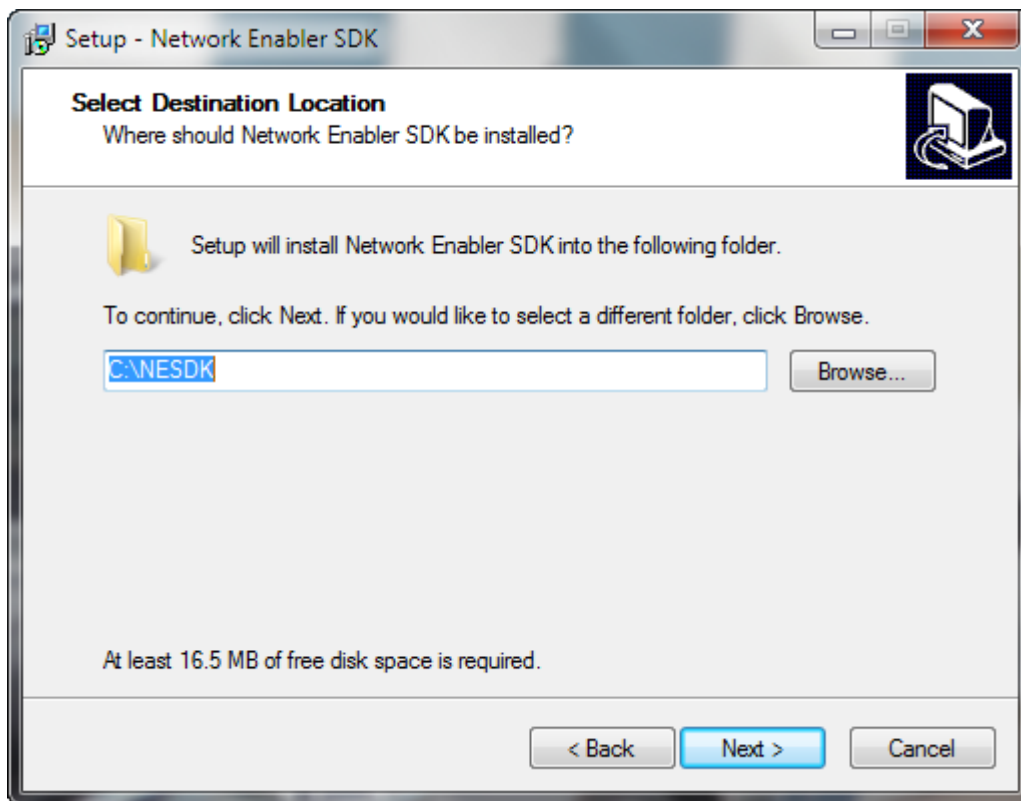

Select where you would like the program installed and click 'Next'.

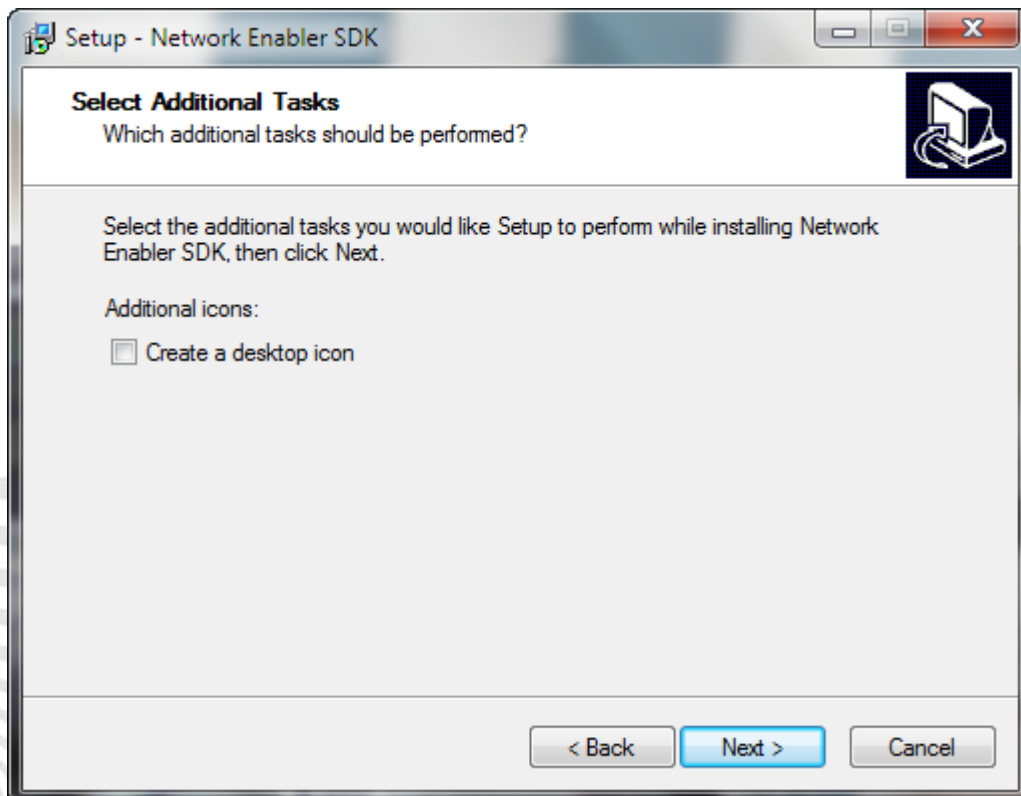

Select whether or not you wish to have an icon on the desktop and click 'Install'.

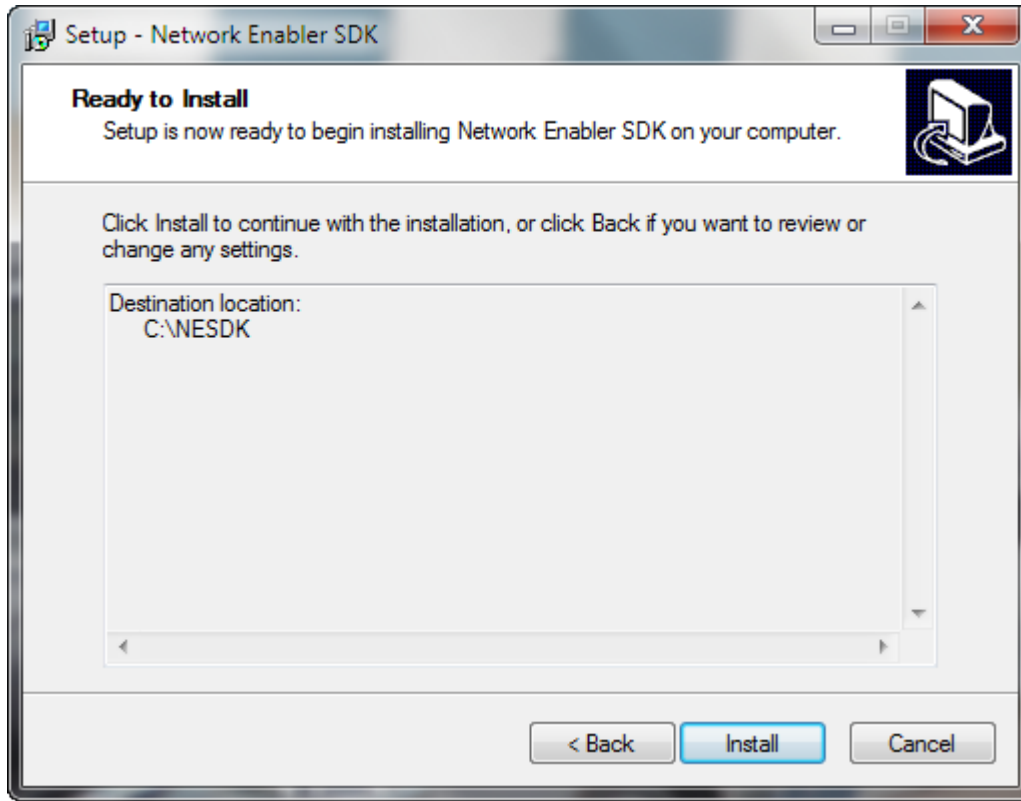

Review the options and click 'Install'.



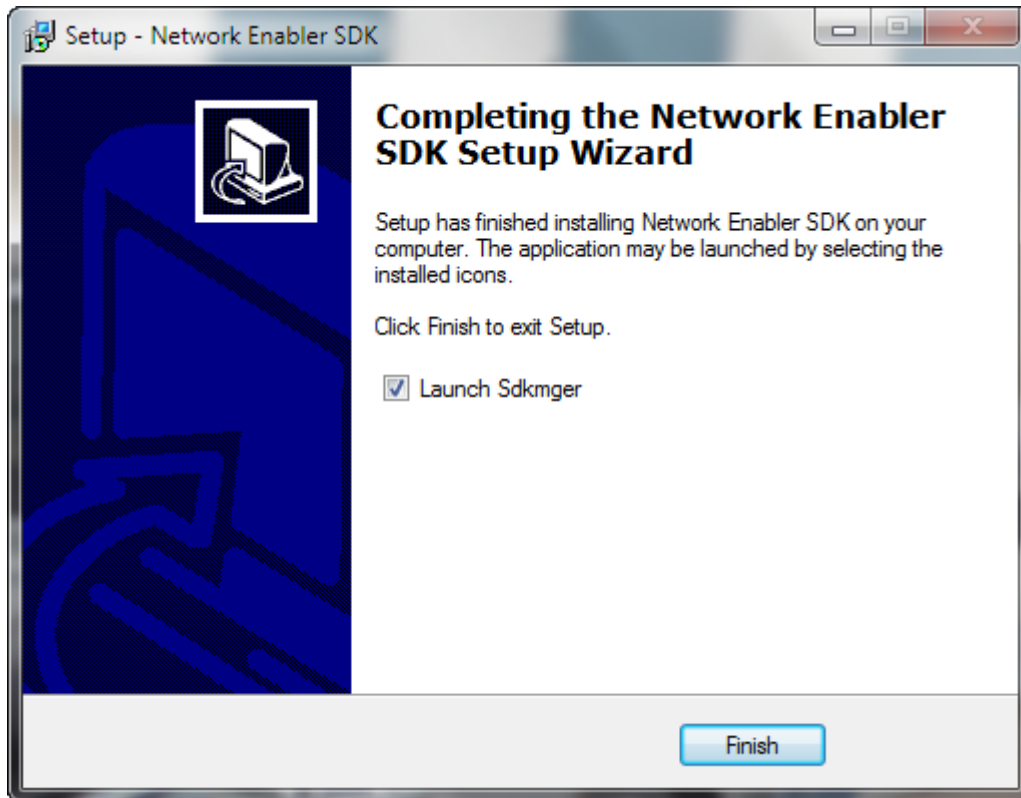

Click 'Finish' to exit the setup program. The Debug program will be started straight away if the option here is left checked.

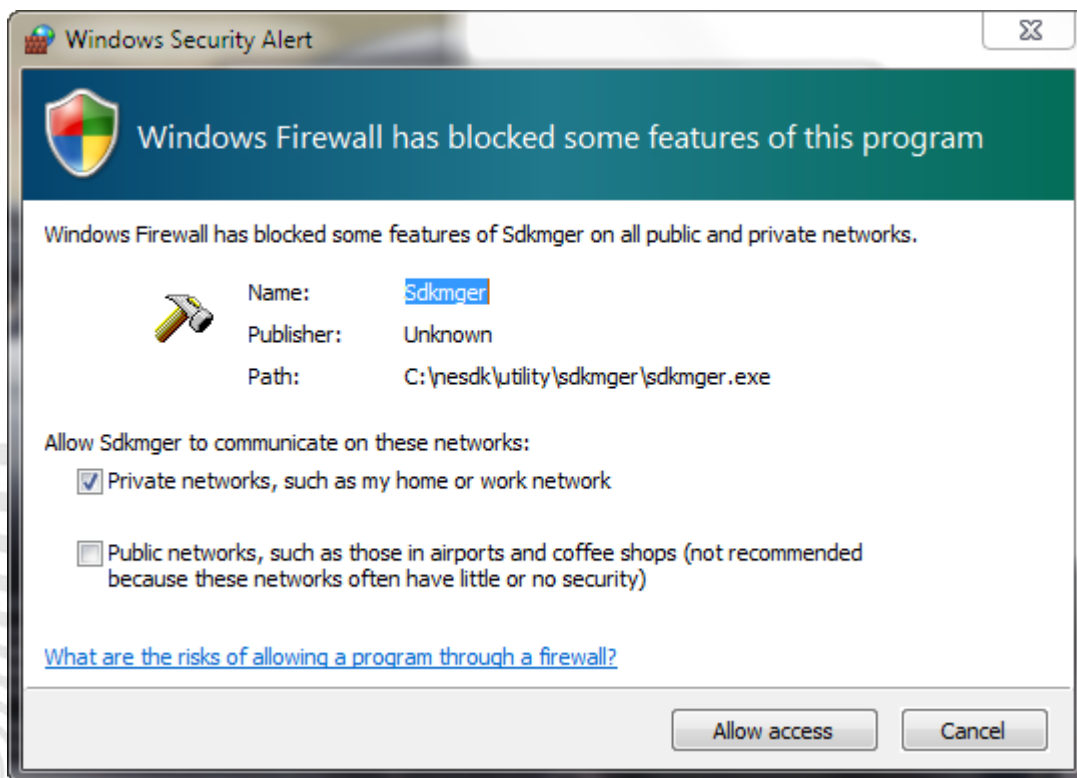

You may get a warning from the PC; you must allow the program access for it to work correctly.

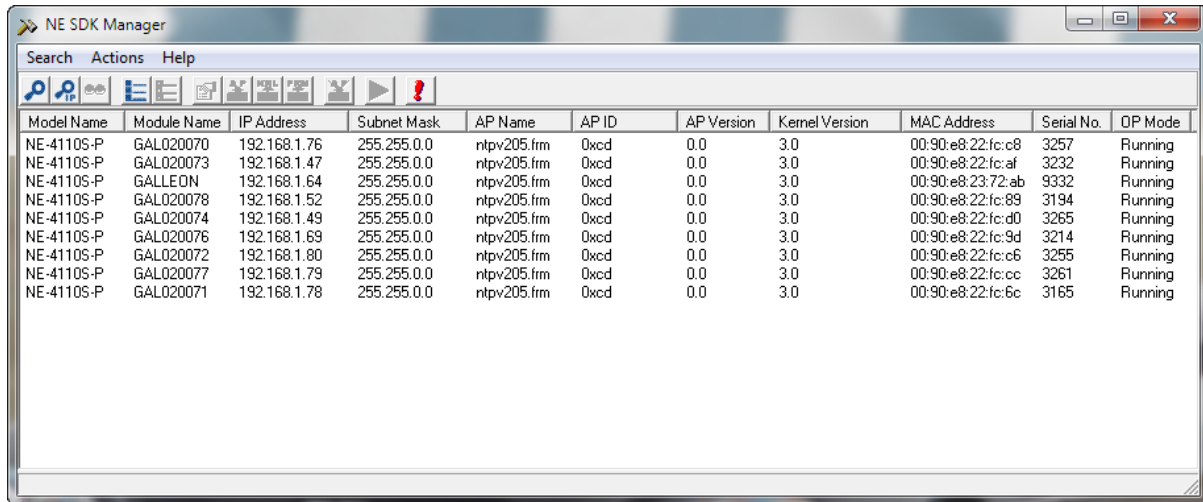

Model Name	Module Name	IP Address	Subnet Mask	AP Name	AP ID	AP Version	Kernel Version	MAC Address	Serial No.	OP Mode
NE-4110S-P	GAL020070	192.168.1.76	255.255.0.0	ntpv205.frm	0xcd	0.0	3.0	00:90:e8:22:fc:c8	3257	Running
NE-4110S-P	GAL020073	192.168.1.47	255.255.0.0	ntpv205.frm	0xcd	0.0	3.0	00:90:e8:22:fc:af	3232	Running
NE-4110S-P	GALLEON	192.168.1.64	255.255.0.0	ntpv205.frm	0xcd	0.0	3.0	00:90:e8:23:72:ab	9332	Running
NE-4110S-P	GAL020078	192.168.1.52	255.255.0.0	ntpv205.frm	0xcd	0.0	3.0	00:90:e8:22:fc:89	3194	Running
NE-4110S-P	GAL020074	192.168.1.49	255.255.0.0	ntpv205.frm	0xcd	0.0	3.0	00:90:e8:22:fc:d0	3265	Running
NE-4110S-P	GAL020076	192.168.1.69	255.255.0.0	ntpv205.frm	0xcd	0.0	3.0	00:90:e8:22:fc:9d	3214	Running
NE-4110S-P	GAL020072	192.168.1.80	255.255.0.0	ntpv205.frm	0xcd	0.0	3.0	00:90:e8:22:fc:c6	3255	Running
NE-4110S-P	GAL020077	192.168.1.79	255.255.0.0	ntpv205.frm	0xcd	0.0	3.0	00:90:e8:22:fc:cc	3261	Running
NE-4110S-P	GAL020071	192.168.1.78	255.255.0.0	ntpv205.frm	0xcd	0.0	3.0	00:90:e8:22:fc:6c	3165	Running

All of the NTS-4000-S Devices found are shown along with their current IP Address (if any), Hardware MAC Address and other System Information.



Using the NESDK Software

The first step to starting the Debugging process is to select the unit you wish to debug from the list, and click the 'Run Application / Debug' button (Blue Triangle).

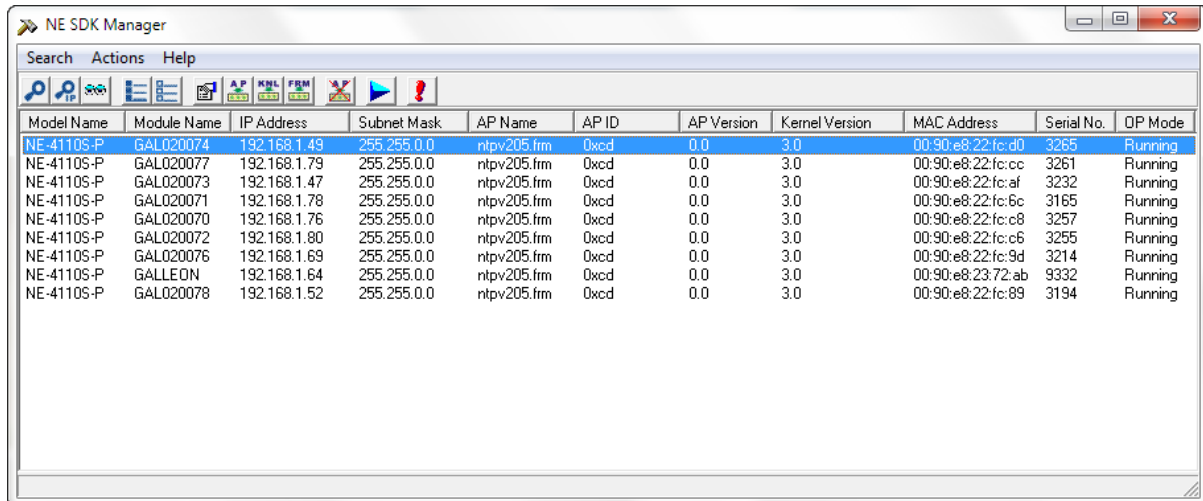

Model Name	Module Name	IP Address	Subnet Mask	AP Name	AP ID	AP Version	Kernel Version	MAC Address	Serial No.	OP Mode
NE-4110S-P	GAL020074	192.168.1.49	255.255.0.0	n1pv205.frm	0xcd	0.0	3.0	00:90:e8:22:fc:d0	3265	Running
NE-4110S-P	GAL020077	192.168.1.79	255.255.0.0	n1pv205.frm	0xcd	0.0	3.0	00:90:e8:22:fc:cc	3261	Running
NE-4110S-P	GAL020073	192.168.1.47	255.255.0.0	n1pv205.frm	0xcd	0.0	3.0	00:90:e8:22:fc:af	3232	Running
NE-4110S-P	GAL020071	192.168.1.78	255.255.0.0	n1pv205.frm	0xcd	0.0	3.0	00:90:e8:22:fc:6c	3165	Running
NE-4110S-P	GAL020070	192.168.1.76	255.255.0.0	n1pv205.frm	0xcd	0.0	3.0	00:90:e8:22:fc:c8	3257	Running
NE-4110S-P	GAL020072	192.168.1.80	255.255.0.0	n1pv205.frm	0xcd	0.0	3.0	00:90:e8:22:fc:c6	3255	Running
NE-4110S-P	GAL020076	192.168.1.69	255.255.0.0	n1pv205.frm	0xcd	0.0	3.0	00:90:e8:22:fc:9d	3214	Running
NE-4110S-P	GALLEON	192.168.1.64	255.255.0.0	n1pv205.frm	0xcd	0.0	3.0	00:90:e8:23:72:ab	9332	Running
NE-4110S-P	GAL020078	192.168.1.52	255.255.0.0	n1pv205.frm	0xcd	0.0	3.0	00:90:e8:22:fc:89	3194	Running

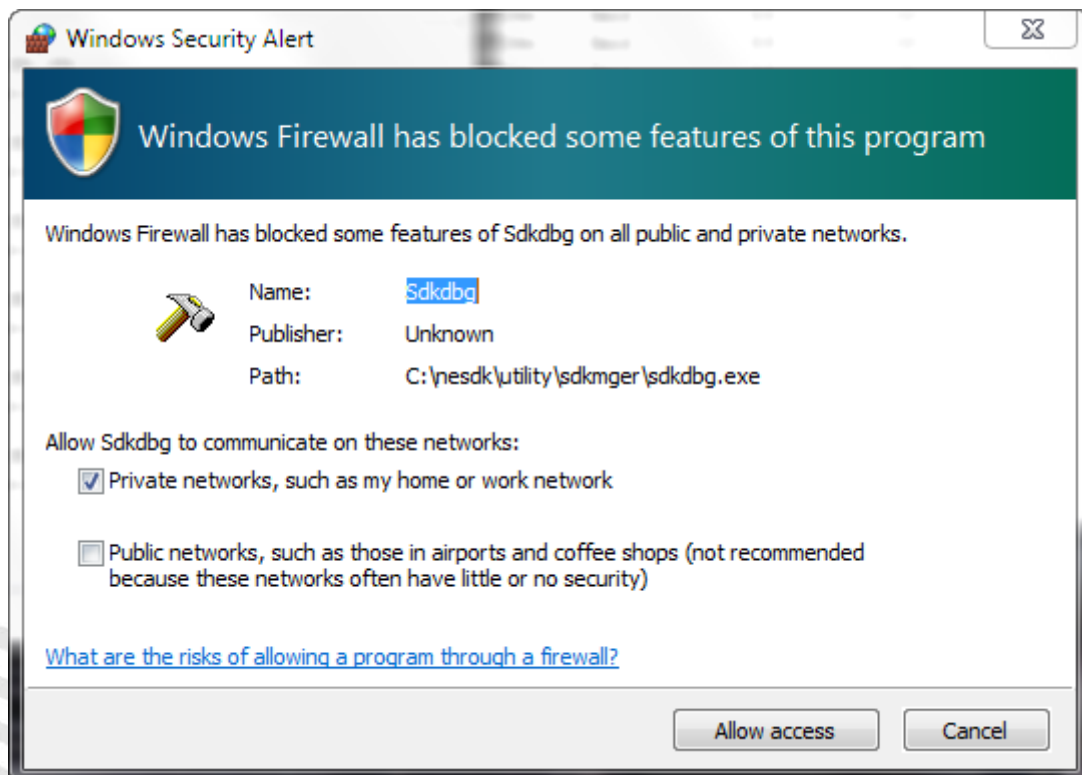

You may get a warning from the PC; you must allow the program access for it to work correctly.

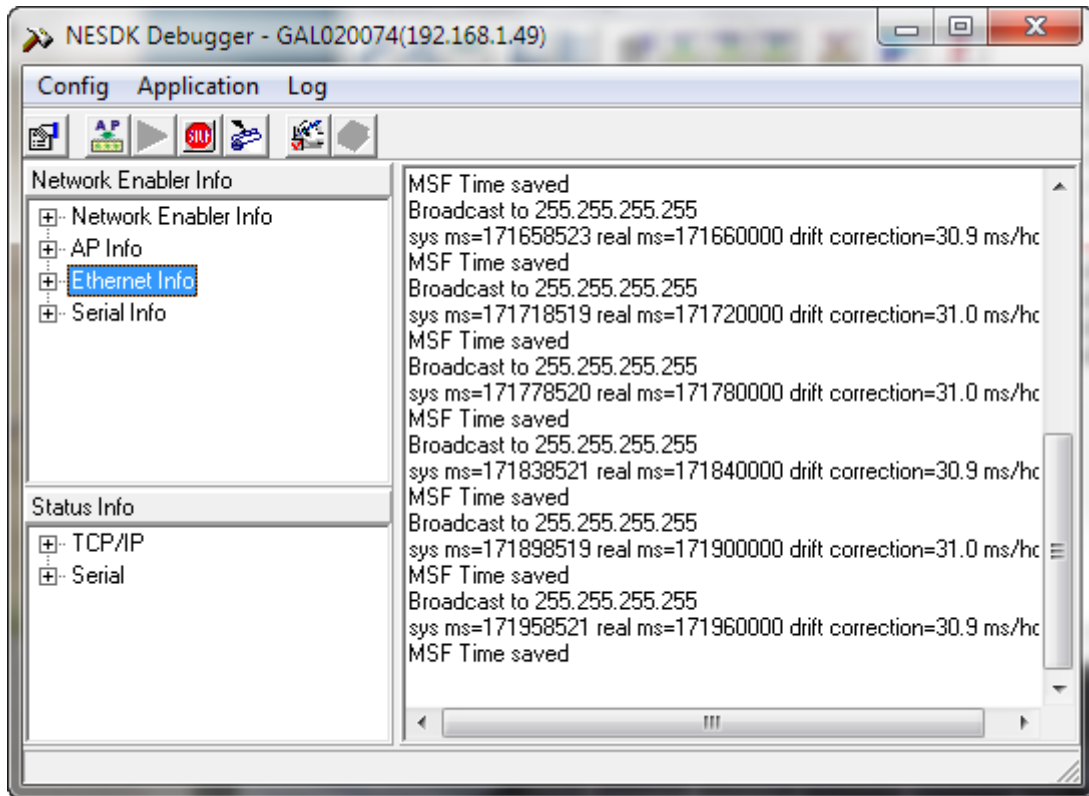

The Debug Window will show whether the unit is synchronised or not as well as other details about the units status. Clicking the 'Start Debug Log' button, allows the software to write the output information to a text file which can be saved and used to aid Technical Support Staff.

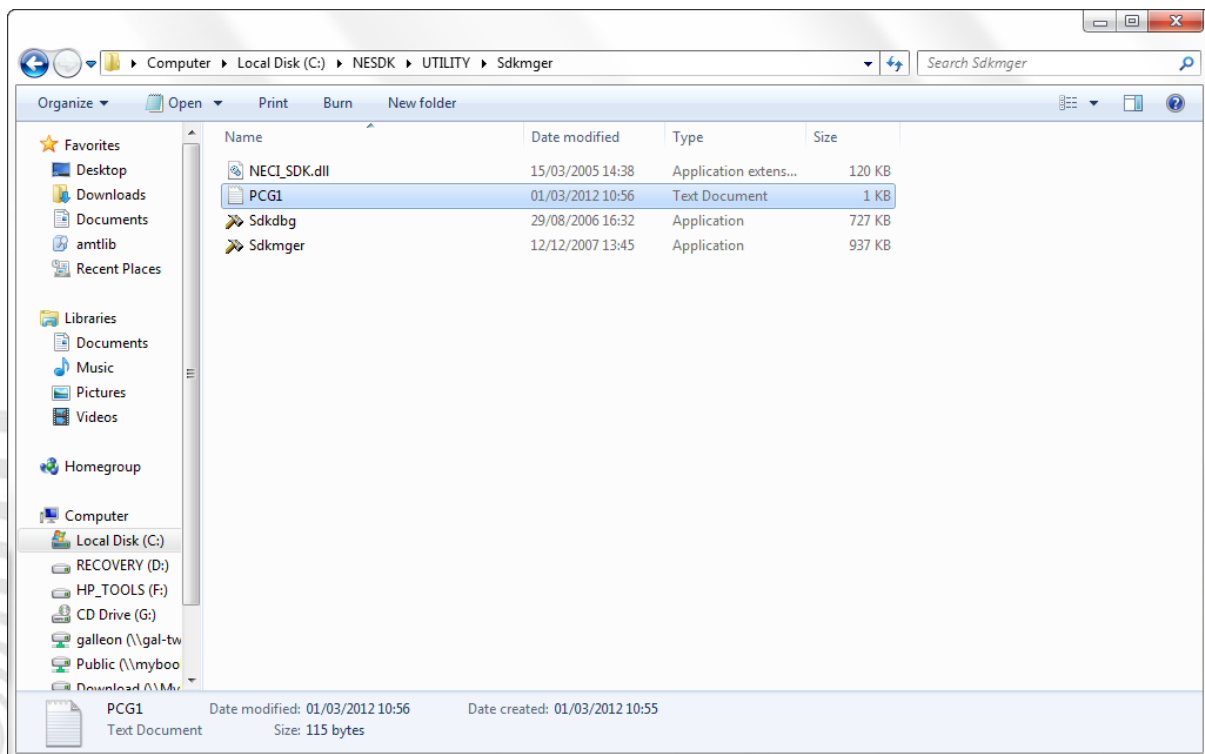

SUPPORT WEBSITE

Should you require any Technical Support on this product, please go to galleonsupport.com where you can find access to the Knowledgebase, for general information.

For any further questions please submit a ticket detailing the problems or technical issues you are having, and a member of the Technical Support Team will be available to support you. When submitting a ticket, please give as much information as possible.

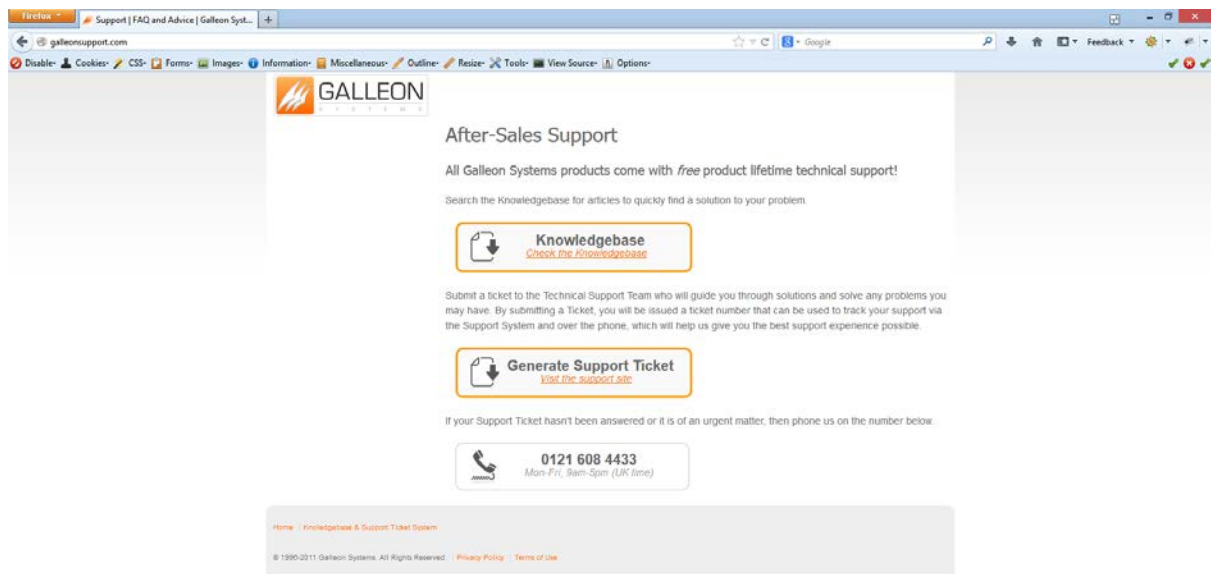

galleonsupport.com website with Knowledgebase and Support Ticket links.



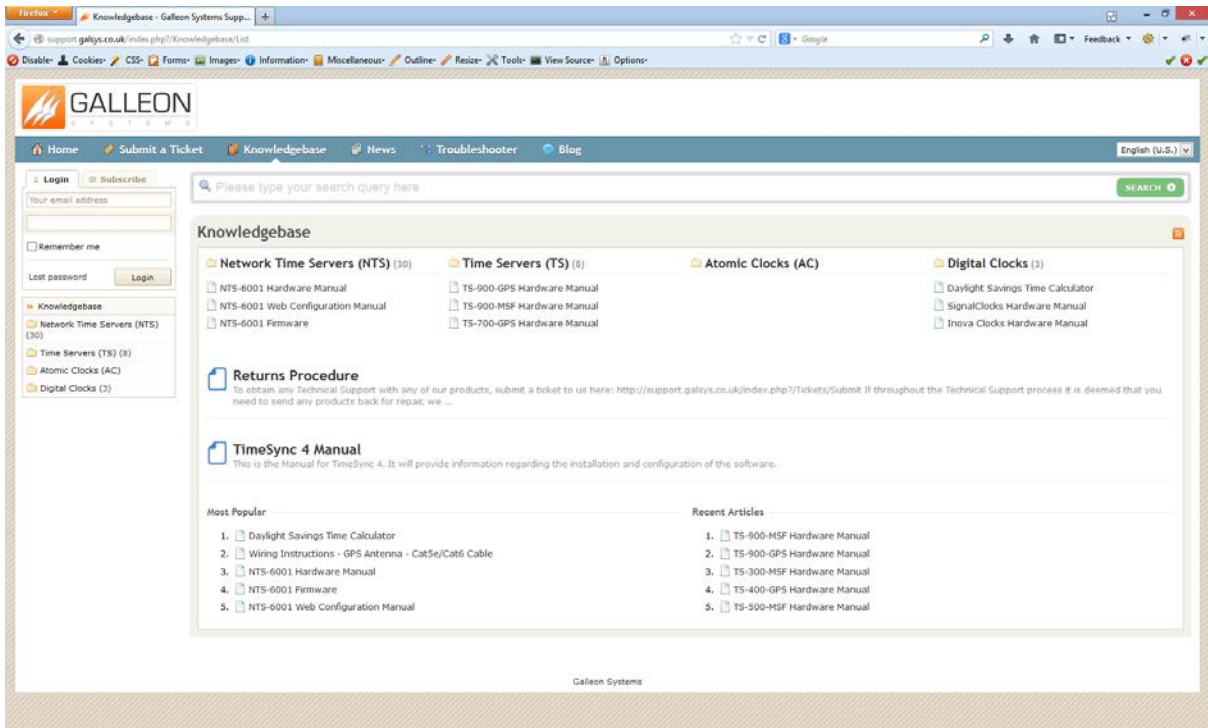

The Technical Support Knowledgebase.

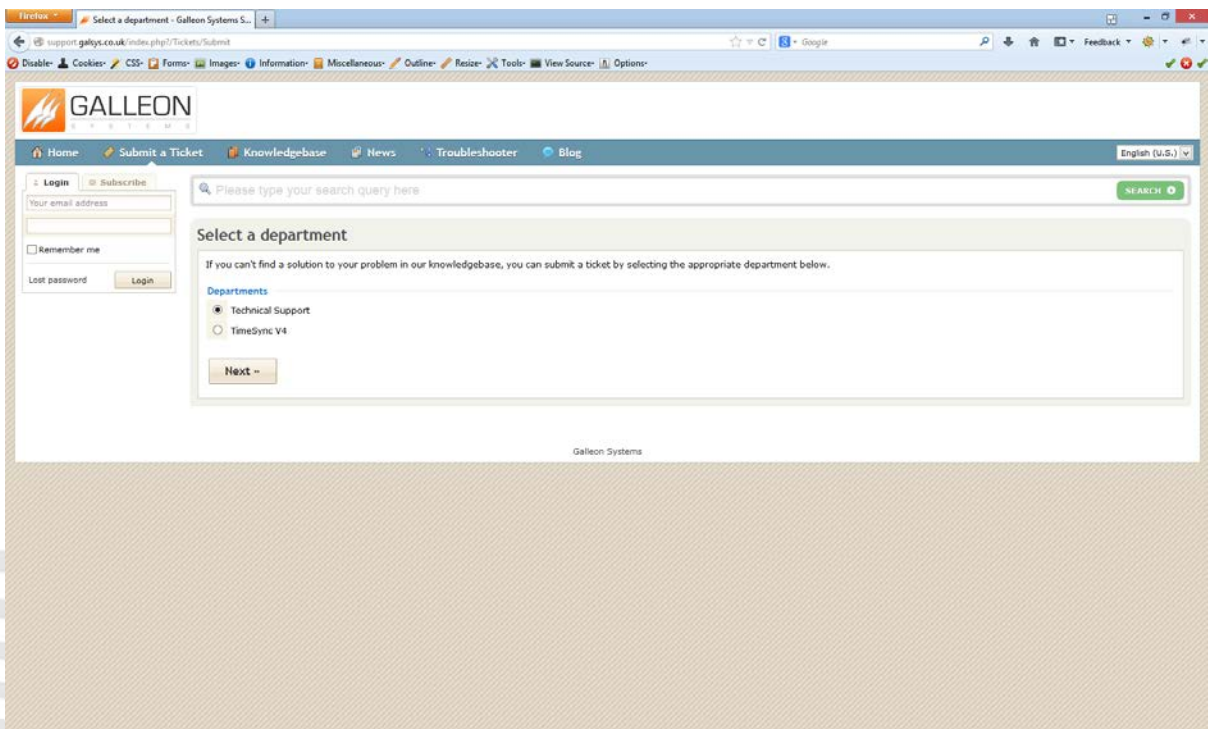

The Technical Support Ticket System.



NTS-4000-S

WARRANTY AND MAINTENANCE

WARRANTY

Galleon Systems warrants the time server to be free from defects in material and workmanship during a six-year period. The Warranty begins on the date the unit is shipped from Galleon Systems. Extended warranties are available by speaking to the Galleon Systems Sales Team.

Galleon Systems' liability under this Warranty is limited to repairing or replacing, at Galleon systems' option, the defective equipment and providing upgrade version changes for firmware. In case of repair, the product must be returned to Galleon systems.

This Warranty does not apply if repairs are required due to acts of nature beyond Galleon systems' control such as, but not limited to, lightning strikes, power surges, misuse, damage, neglect, or if repairs/modifications have been made or attempted by anyone other than personnel authorised by Galleon Systems.

In no event will Galleon Systems be liable for any indirect, special, incidental or consequential damages from the sale or use of this product.

This disclaimer applies both during and after the term of the warranty. Galleon Systems disclaims liability for any implied warranties, including implied warranties of merchantability and fitness for a specific purpose.

TECHNICAL SUPPORT, REPAIR AND RETURNS

To obtain any Technical Support with this product, contact Galleon Systems via the Support Website – galleonsupport.com

If throughout the Technical Support process it is deemed that you need to send any products back for repair, we will issue a Return Material Authorisation (RMA) Number and shipping instructions. Then ship the product, transportation prepaid, for inspection.

Typical Equipment repair or replacement time is five (5) business days, plus shipping times. One-way shipping is the customer's responsibility. Galleon Systems will return ship the equipment by the same means it was received.

Galleon Systems will not be responsible for unauthorised returns or for returns that do not list the RMA Number on a packing list attached in plain view on the outside of the shipping container.

